

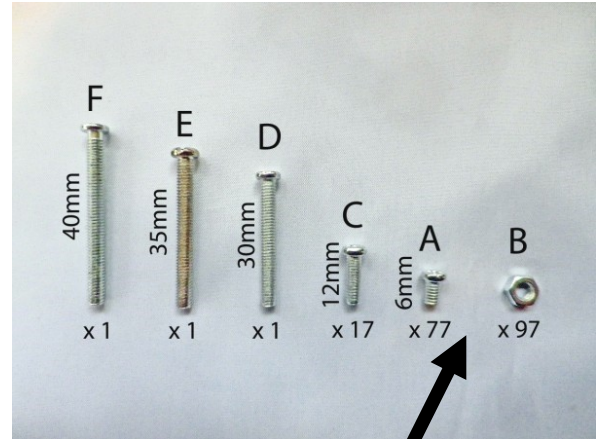

Eiffel Tower in a Tin

This kit contains all you need to make your own Eiffel Tower. Follow the step by step guide - it should take 2 to 3 hours to build your tower!



For all joints use bolt A and nut B unless shown. Make sure all nuts are tight as you build.

NOW START BUILDING !!

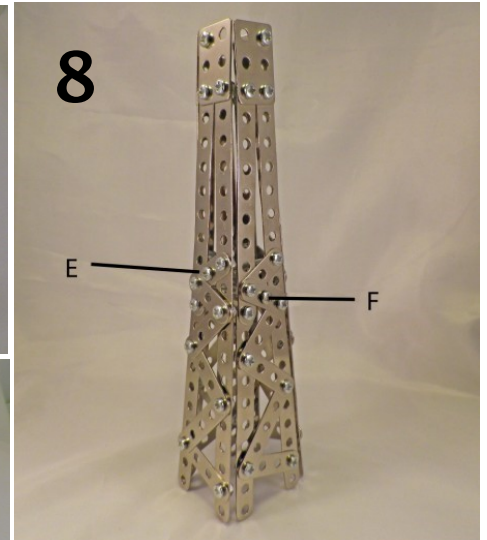
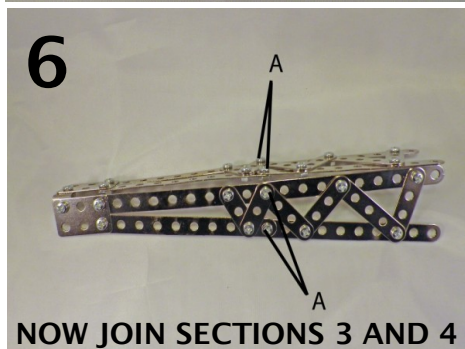
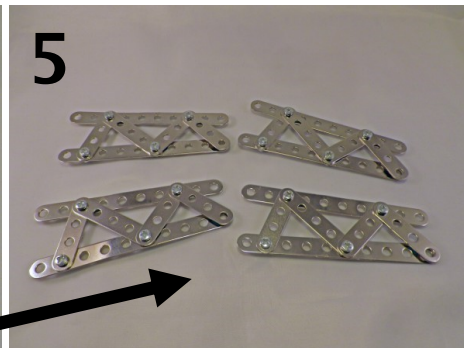
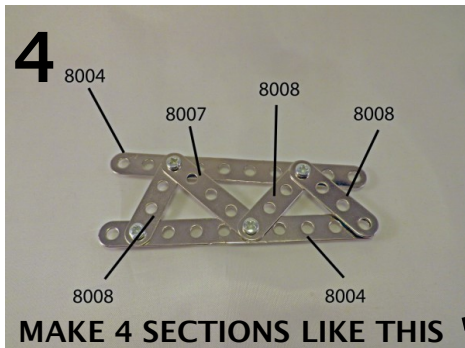
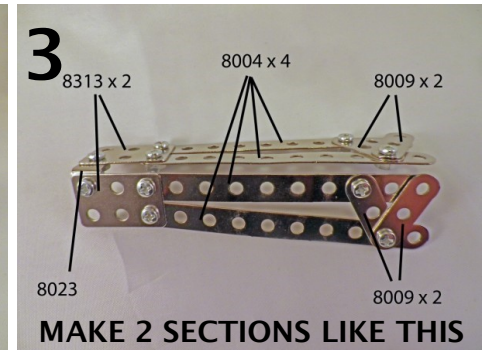
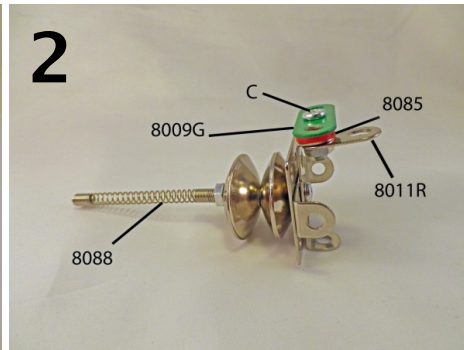
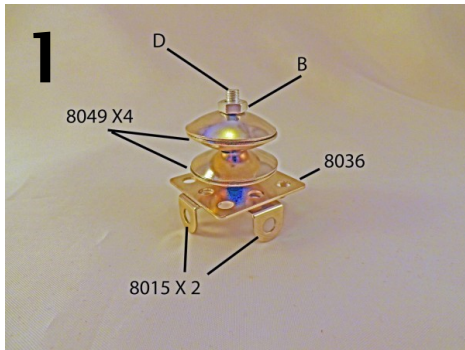

ADD LONG BOLTS E and F TO HOLD ALL PARTS TOGETHER

YOUR TOWER SHOULD NOW LOOK LIKE THIS

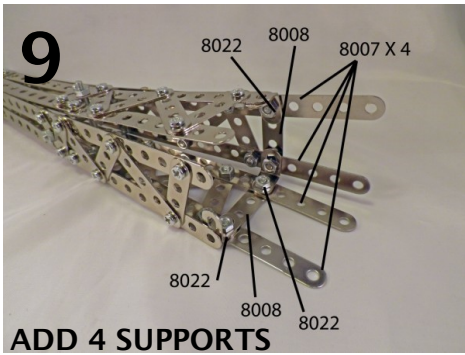

9
ADD 4 SUPPORTS

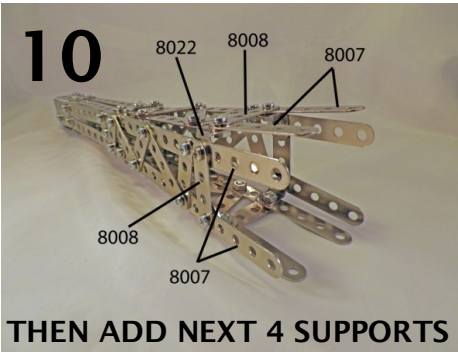

10
THEN ADD NEXT 4 SUPPORTS



11
BASE SHOULD LOOK LIKE THIS

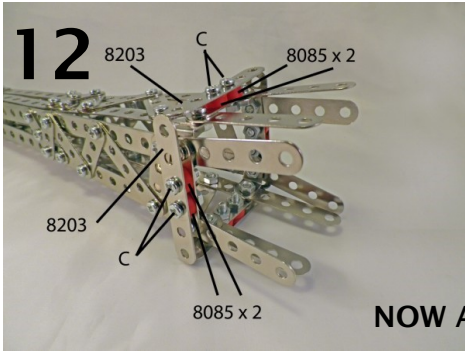

12
8203 C 8085 x 2
8203 C 8085 x 2

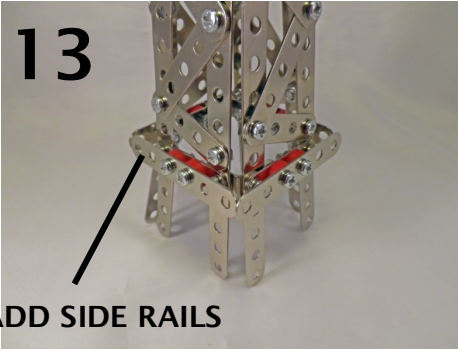

13
NOW ADD SIDE RAILS

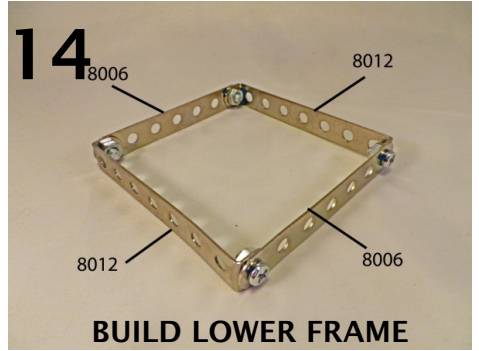

14
8006 8012
8012 8006
BUILD LOWER FRAME

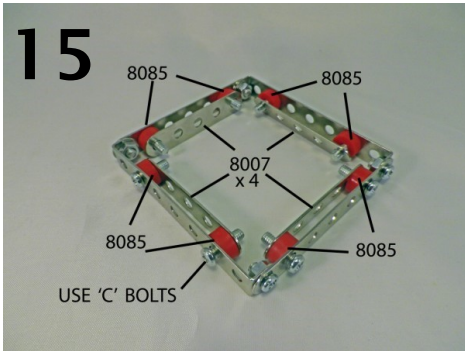

15
8085 8085
8007 x 4
8085 8085
USE 'C' BOLTS

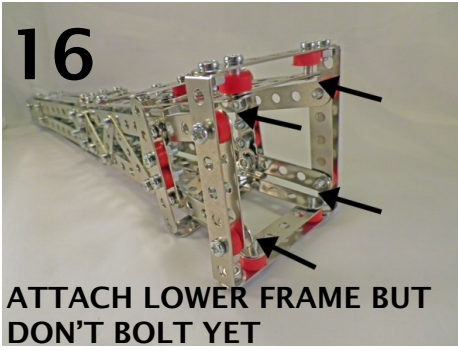

16
ATTACH LOWER FRAME BUT DON'T BOLT YET

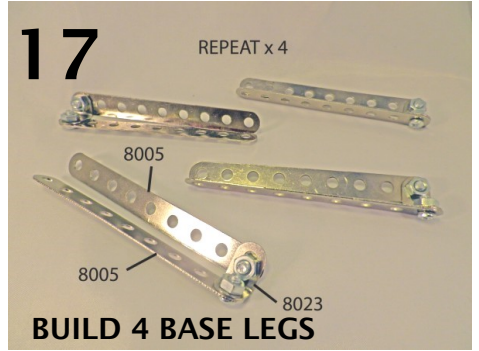

17
REPEAT x 4
8005 8023
BUILD 4 BASE LEGS

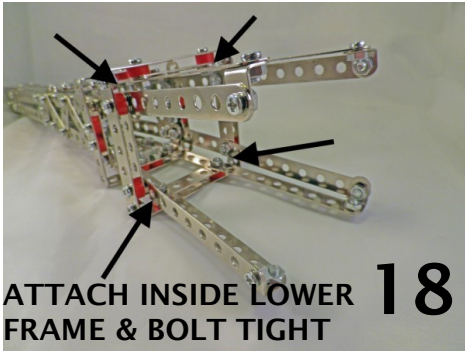

18
ATTACH INSIDE LOWER FRAME & BOLT TIGHT

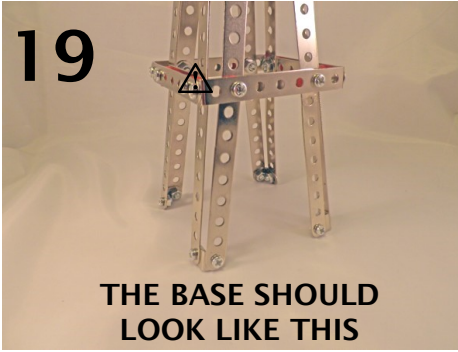

19
THE BASE SHOULD LOOK LIKE THIS

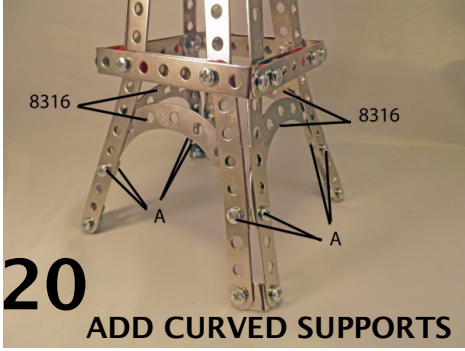

20
ADD CURVED SUPPORTS

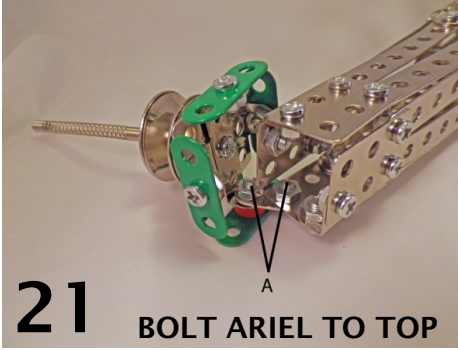

21
BOLT ARIEL TO TOP



22
CONGRATULATIONS!
YOU ARE FINISHED!

Produced by Apples to Pears Ltd., Stroud, U.K.

www.applestopears.com

PLEASE KEEP THESE INSTRUCTIONS FOR FUTURE REFERENCE

Copyright © Apples to Pears Ltd 2014. RECOMMENDED AGE 8+

apples 
to pears



WARNING

CHOKING HAZARD Small parts, not suitable for children under 3yrs.
FUNCTIONAL SHARP POINT adult supervision recommended.